

Article number: 04085634

Description: Stabilus Lift-O-Mat Gas Spring 085634 1900N
03 14 250 1900 Eyelet/Eyelet

Measures

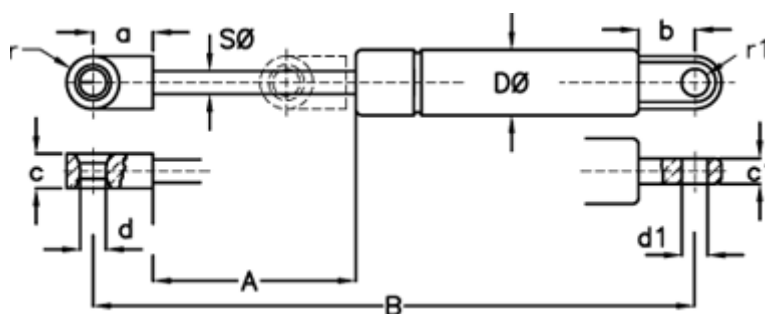

A = 250

a = 24

B = 600 +/-2

b = 15

c = 18

c1 = 8

d1 = 10,1 +0,1 -0,2

d = 10,1 +0,1

D = 28

Fixing = Øje/Øje

Material = Metal

Note = -

Note = -

r = 9

r1 = 8

S = 14